

---

Manual Part # 99900838

# CAS440HT Air Compressor

Revised 20120124



IOWA MOLD TOOLING CO., INC.

PO Box 189

Garner, IA 50438

Tel: 641-923-3711 FAX: 641-923-2424

Website: <http://www.imt.com>

Copyright © 2012 Iowa Mold Tooling Co., Inc.  
All rights reserved

No part of this publication may be reproduced, stored in a retrieval system, or transmitted in any form or by any means, electronic, mechanical, photocopying, recording or otherwise without the prior written permission of Iowa Mold Tooling Co., Inc.

Iowa Mold Tooling Co., Inc. is an Oshkosh Corporation Company.



# Contents

Revisions .....	ii
<b>Compressor Introduction</b>	<b>3</b>
Compressor Precautions .....	5
Compressor Safety .....	6
Compressor Information Record.....	7
CAS440HT Recommended Spare Parts .....	8
<b>CAS440HT Compressor Specifications</b>	<b>9</b>
<b>Installation</b>	<b>11</b>
PTO & Pump Installation .....	11
PTO Installation.....	11
Driveline and Pump Installation .....	13
Topdeck Compressor Installation .....	15
Oil Cooler (optional).....	17
<b>Operation</b>	<b>19</b>
Operation .....	19
Shutdown .....	20
<b>Maintenance &amp; Repair</b>	<b>21</b>
Maintenance Schedule .....	22
Compressor Hydraulic Oil .....	23
Hydraulic Fluid Deterioration.....	24
Compressor Hydraulic Oil Change .....	25
Compressor Filter Element Replacement .....	26
Drive Belt .....	26
Compressor Hydraulic System Precautions .....	27
Troubleshooting Guide .....	28
<b>Parts</b>	<b>29</b>
CAS440HT Compressor Parts (23000080).....	30
Thread Torque Charts .....	33

---

## Revisions

DATE	LOCATION	DESCRIPTION
20070817	MAINTENANCE SCHEDULE, 2300080	CHANGED MAINTENANCE SCHEDULE COMPRESSOR OIL CHANGE DURATION; ECN 10523 – CHANGED #28 72066516 TO 72661642
20071127	MAINT. SCHEDULE	ECN 10612 - CHANGED NOTE IN MAINTENANCE SCHEDULE TO 6 MONTHS
20090409	23000080	ADDED CALLOUT FOR ITEM #9 - MOTOR; ADDED SPECIFICATIONS SECTION
20110610	23000080	ECN 11448 - NEW PRESSURE RELIEF VALVE.
20120124	23000080	ECN 11616 - CHANGED MOTOR MOUNTING BRACKET

---

## SECTION 1

# Compressor Introduction

This volume provides information on the installation, operation, and repair of IMT hydraulic air compressors. In addition to reading the manual, it is your responsibility to become familiar with government regulations, hazards, and the specific operation of your equipment. Use caution and common sense while operating and maintaining the equipment and follow all safety procedures and regulations. Treat this equipment with respect and service it regularly.

### MODIFICATIONS

Modifications to your equipment must be performed with IMT approved accessories, parts and optional equipment. If in doubt, contact IMT prior to making any modifications. **DO NOT** alter or modify any safety device! All safety devices must be inspected, tested and maintained in proper working condition.

Decals regarding safety and operation are considered safety equipment, and must be kept clean and legible.

The equipment owner and/or designated employee is responsible for informing all operators, maintenance personnel, and others involved in equipment operation about the safe operation and maintenance of the equipment. If questions arise concerning safe operation, contact IMT or your IMT distributor for clarification.

### WARRANTY

Warranty of this unit will be void on any part of the unit subjected to misuse due to overloading, abuse, lack of maintenance and unauthorized modifications. No warranty - verbal, written or implied - other than the official, published IMT new machinery and equipment warranty will be valid with this unit.

### NOTICE TO THE OWNER / USER

If your equipment is involved in a property damage accident, contact your IMT distributor immediately and provide them with the details of the accident and the serial number of the equipment. If an accident involves personal injury, immediately notify your distributor and IMT Technical Support at:

IOWA MOLD TOOLING CO., INC.  
500 HWY 18 WEST  
GARNER, IA 50438  
641 - 923 - 3711

## WARNING

READ YOUR MANUAL!! FAILURE TO READ, UNDERSTAND AND FOLLOW ANY SAFETY PROCEDURES APPLICABLE TO YOUR EQUIPMENT MAY RESULT IN EQUIPMENT DAMAGE, SERIOUS INJURY, OR DEATH.

## MANUAL STRUCTURE

Throughout this manual, three means are used to draw the attention of personnel. They are NOTES, CAUTIONS and WARNINGS and are defined as follows:

## NOTE

A NOTE is used to either convey additional information or to provide further emphasis for a previous point.

## CAUTION

A CAUTION is used when there is the very strong possibility of damage to the equipment or premature equipment failure.

## WARNING

A WARNING is used when there is the potential for personal injury or death.

# Compressor Precautions











7-1303886

⚠ DANGER

EXPLODING TANK WILL CAUSE DEATH, SERIOUS INJURY OR PROPERTY DAMAGE

- Drain air tank after each use to prevent moisture build-up and corrosion which leads to tank failure.
- Assure that tank and compressor relief valves work properly, and are at correct pressure settings.
- **DO NOT** modify or repair air tank.
- **NEVER** drive vehicle with pressure in air tank.

	Failure to follow operating and maintenance procedures as outlined in this manual could result in equipment damage, personal injury or death. Follow all maintenance procedures and intervals.
	Maintenance must be performed only by trained and qualified personnel, using correct tools, specified torques and approved replacement parts.
	All electrical components and cable wiring must be installed and grounded in accordance with NFPA, national electrical codes and applicable state and local codes.
	Before removing guards or servicing the compressor, disconnect all power supplies. Display warning signs and lock out electrical circuits.
	All guards must be in position and secure before and during operation.

	Do not use air from this compressor for breathing or food processing. Air from this compressor will cause severe injury or death if used for breathing or food processing.
	Hot oil under pressure can cause severe injury or death. Shut down, let cool and relieve pressure in compressor before servicing.
	Do not overfill the compressor with oil. Use correct quantity of manufacturer's lubricant. Repair leaks and clean spills immediately.
	Compressors generate high temperatures. Do not touch or otherwise come in contact with hot surfaces. Doing so can cause severe personal injury.

---

# Compressor Safety

## WARNING

**AVOID PERSONAL INJURY OR PROPERTY DAMAGE! READ YOUR MANUAL!** All units are shipped with a detailed operators and parts manual which contains vital information for the safe use and efficient operation of this unit.

## AIR COMPRESSOR SAFETY PRECAUTIONS

Safety is basically common sense. While there are standard safety rules, each situation has its own peculiarities that cannot always be covered by rules, and with your experience and common sense, you are in a position to ensure your safety. Lack of attention to safety can result in death, serious injury, accidents, and efficiency reductions. Watch for safety hazards and correct them promptly. Use the following safety precautions as a general guide to safe operation:

- Do not attempt to remove any compressor parts without first relieving the entire system of pressure.
- Do not attempt to service any part while the machine is operating.

## WARNING

**AVOID PERSONAL INJURY OR PROPERTY DAMAGE!** Check the compressor sump oil level only when the compressor is not operating and the system is completely relieved of pressure. Open the service valve to ensure relief of system air pressure when performing maintenance on compressor air/oil system.

- Do not operate the compressor at pressure or speed in excess of its rating as indicated in Compressor Specifications.
- Periodically check all safety devices for proper operation.
- Do not play with compressed air. Pressurized air can cause serious injury to personnel.
- Exercise cleanliness during maintenance and when making repairs. Keep dirt away from parts by covering parts and exposed openings.
- Do not install a shut-off valve between the compressor and compressor oil sump.

## DANGER

**AVOID DEATH OR SERIOUS INJURY!**

Do not use IMT compressor systems to provide breathing air. Such usage, whether supplied immediately from the compressor source, or supplied to breathing tanks for subsequent use, can cause serious bodily injury.



IMT disclaims any and all liabilities for damage for loss due to personal injuries, including death, and/or property damage including consequential damages arising out of any IMT compressors used to supply breathing air.

- Do not disconnect or bypass safety circuit system.
- Do not install safety devices other than authorized IMT replacement devices.
- Close all openings and replace all covers and guards before operating compressor unit.
- Do not leave tools, rags, or loose parts on the compressor or drive parts.
- Do not use flammable solvents for cleaning parts.
- Keep combustibles out of and away from the compressor and any associated enclosures.

The owner, lessor, or operator of the compressor are hereby notified and forewarned that any failure to observe these safety precautions may result in damage or injury.

*IMT expressly disclaims responsibility or liability for any injury or damage caused by failure to observe these specified precautions or by failure to exercise that ordinary caution and due care required when operating or handling the compressor, even though not expressly specified above.*

## Compressor Information Record

TO BE COMPLETED BY DEALER	
CHASSIS INFORMATION	
TRANSMISSION MAKE:	MODEL:
PTO NUMBER:	PTO %:
COMPRESSOR AND HYDRAULIC PUMP INFORMATION	
COMPRESSOR MODEL:	SERIAL NUMBER:
PUMP MAKE:	MODEL:
RESERVOIR CAPACITY:	ENGINE RPM:

## CAS440HT Recommended Spare Parts

### Recommended Spare Parts for one-year for CAS440HT Top-deck Compressor:

NOTE: This spare parts list does not necessarily indicate that the items can be expected to fail in the course of a year. It is intended to provide the user with a stock of parts sufficient to keep the unit operating with the minimal down-time waiting for parts. There may be parts failures not covered by this list. Parts not listed are considered as not being Critical or Normal Wear items during the first year of operations and you need to contact the distributor or manufacturer for availability.

PART NO.	DESCRIPTION	QTY	CODE
COMPRESSOR ASSEMBLY COMPONENTS (23000080)			
70058486	BELT	1	P
73051614	HYDRAULIC MOTOR	1	W
73540449	RELIEF VALVE	1	W
70048069	MOISTURE REGULATOR	1	P
73052092	RETURN FILTER	1	P
COMPRESSOR (70073051)			
70073727	LP INTAKE VALVE	1	W
70073726	LP EXHAUST VALVE	1	W
70732447	HP INTAKE VALVE	1	W
73054340	HP EXHAUST VALVE	1	W
70073766	RING SET	1	W
70143298	RELEASE VALVE KIT	1	W
70732429	INTERCOOLER TUBE LH	1	W
70732430	INTERCOOLER TUBE RH	1	W
70732448	KIT - VALVE SET	1	P
76391490	SHAFT SEAL	1	W
73054339	POP-OFF, 70 psi	1	W
73054031	PILOT VALVE	1	C

## SECTION 2

# CAS440HT Compressor Specifications

	CAS440HT
DELIVERY AT 175 PSI	46 cfm (1300 lpm)
FLUID CAPACITY	32 gal (121 l)
FILTER - HYDRAULIC SUCTION	100 mesh
FILTER - HYDRAULIC RETURN	10 microns
PRESSURE SWITCH	175 psi off / 150 psi on (12 psi off/ 10 psi on)
COMPRESSOR PULLEY RPM	980 rpm (900 - 1000)
NORMAL OPERATING PRESSURE	1850 psi (130 bar)
MAXIMUM PRESSURE	2400 psi (165 bar)
GPM	16 gpm (60 lpm)
MOTOR PULLEY DIAMETER	10.75" (27 cm)
COMPRESSOR PULLEY DIAMETER	18.88" (48 cm)



---

## SECTION 3

# Installation

---

## PTO & Pump Installation

In some cases the customer or his agent may have to install a compressor, PTO, and pump. These instructions will provide general information to assist with installation. The pump may be installed either directly on the PTO or may be driven by a driveline.

---

## PTO Installation

A power take-off (PTO) must be properly matched to the vehicle's transmission as well as the requirements of the crane. In order to properly select a PTO the following information is needed:

- 1 Make and model of transmission in the carrier vehicle.
- 2 Power requirements of the crane being driven.
- 3 Necessary PTO speed.
- 4 Direction in which the PTO must turn.
- 5 PTO torque required.

If possible, use a hydraulic pump directly mounted to the PTO. This will eliminate an auxiliary driveshaft and it is easier to install as it eliminates driveline angle and phasing errors. It is also quieter and should require less maintenance since driveline lubrication will not be necessary.

PTO manufacturers provide specific installation instructions with their products. Their instructions should be followed when installing the PTO. The following steps are provided as an introduction to the installation.

### NOTE

**IT MAY BE NECESSARY TO REMOVE AND MODIFY EXHAUST COMPONENTS TO PROVIDE SPACE FOR PTO CLEARANCE.**

- 1 Chock the wheels of the vehicle.
- 2 Secure any part attached to or on the vehicle which could move or pose a hazard.

- 3 Run the engine and transmission in a well ventilated area. Listen for noises which indicate any engine/transmission problems. The engine and transmission should be in good operating condition before the installation of the PTO.
- 4 Become familiar with the PTO manufacturer's installation instructions, warnings, and precautions.
- 5 After the engine and transmission have cooled, drain the transmission fluid. Check the fluid for signs of damage such as metal chips, etc.
- 6 With the vehicle engine "Off", visually inspect the transmission for gear damage or foreign particles lodged between gear teeth.
- 7 Remove the PTO from its shipping container. Inspect for foreign objects which may have lodged in the PTO cavity.
- 8 Mount the PTO per manufacturer's instructions.
- 9 Check backlash per manufacturer's instructions.
- 10 Refill the transmission with manufacturer's recommended lubricant to the proper level.
- 11 Install the shifter cable to suit conditions. Always allow a slight overshift on lever or knob to make certain PTO is fully engaged.

**CAUTION**

---

AVOID SHARP BENDS IN THE SHIFTER CABLE. ALL BENDS SHOULD HAVE A MINIMUM 6" RADIUS. TIGHTER BENDS CAUSE DIFFICULT OPERATION OF THE SHIFTER CABLE.

---

- 12 Make sure the vehicle has all safety and operation decals.
- 13 Start the engine, engage the PTO and allow to run for 5 to 10 minutes. Check for leaks, unusual noise and proper operation.
- 14 Check PTO mounting bolts for proper torque as specified by manufacturer.

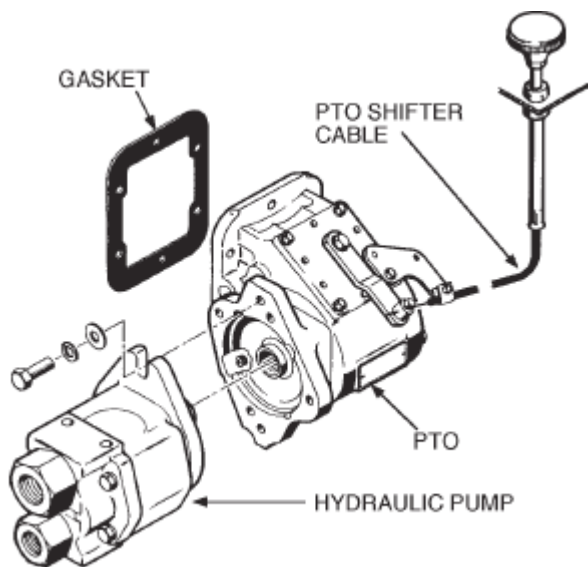

---

## Driveline and Pump Installation

The pump may be driven using a driveline rather than directly mounting to the PTO. The following steps are a guide in this application.

### NOTE

Before installing driveline, refer to instructions for proper driveline installation techniques.

- 1 Install the PTO (*see instructions*).
- 2 Loosely bolt the pump mounting bracket to the adjustable bracket.
- 3 Bolt the adjustable bracket to the frame at a point that will not exceed 48" (122cm) from the PTO and will not cause a joint angle greater than 8°.
- 4 Check the pump rotation. Install pump, pump end yoke and PTO end yoke.
- 5 Size, cut and weld the driveline to the necessary length. Ensure driveline balance and run out meet specification. Allow 1" (2.54 cm) extra for PTO end yoke.
- 6 Install driveline in phase with proper operating angle calculations. Lock set screws. Grease U-joints and mating spline.
- 7 Ensure all mounting bolts are tight.

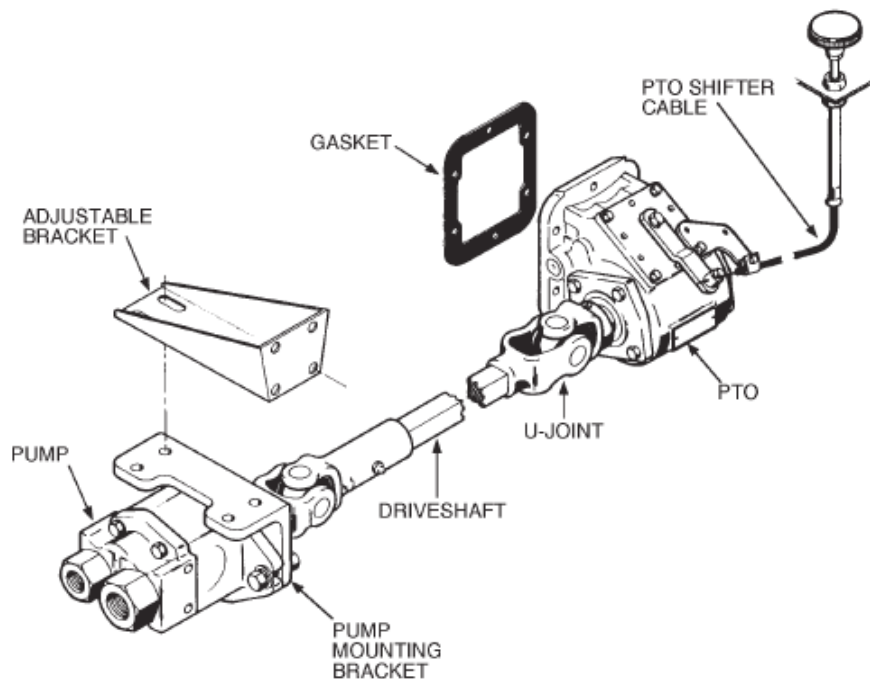



## WARNING

**AVOID DEATH OR SERIOUS INJURY!** The driveline installer must inspect the final position of the driveline to determine whether an operator or other personnel are protected from rotating driveline hazards. If the protection is insufficient, a guard **MUST** be installed. Contact IMT for information on installing a guard.



## Topdeck Compressor Installation

The topdeck compressor is mounted on an oil reservoir which is bolted to the deck of the carrier vehicle. Due to variations, use these instructions only as a guide.

- 1 Locate compressor position on the deck. Layout mounting hole pattern per figure. Drill six 1/2" holes for mounting. Locate the positions of reservoir ports per figure.

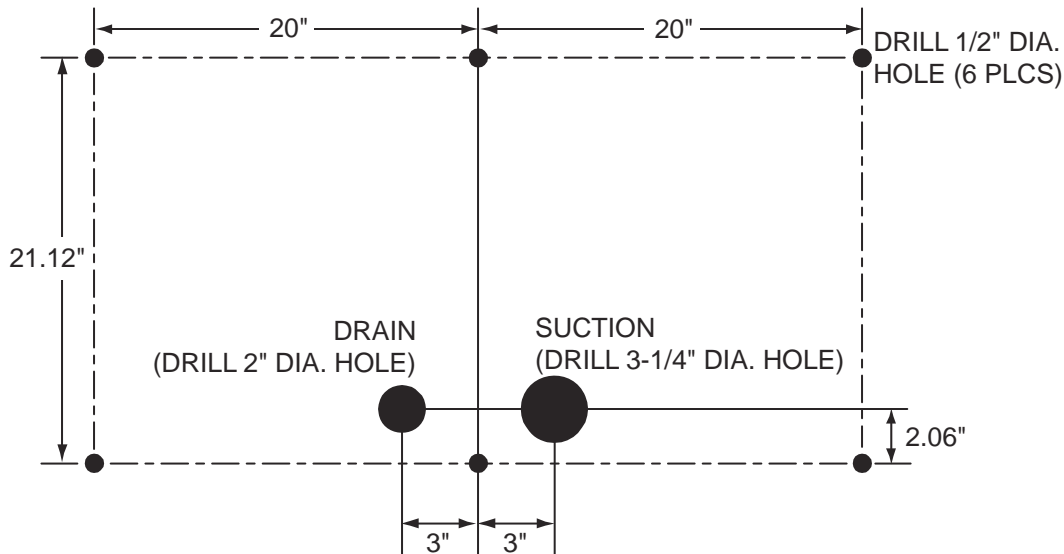

- 2 Using 3/8" bolts, flat washers, lock washers and nuts, secure the compressor and tank to the deck of the truck.
- 3 Locate a position on the deck for a hole for the hose which runs from the pump to the control valve. Position the hole to provide the least interference with truck frame members, exhaust and driveshaft, and as near the compressor oil reservoir as possible. Drill a 1-3/4" hole at this location. Place a 1-3/4" diameter grommet into the hole to help prevent hose wear.
- 4 Route the hose through the hole and connect it to the pump and control valve using the fittings provided.
- 5 Drill a 2-1/4" hole in the bed of the truck for the hose from the cooler to the inlet side of the return filter. Install 2-3/4" diameter grommet into hole. Position the hole to provide the least interference with truck frame members, exhaust and driveshaft; and as near the compressor reservoir as possible. Install hose from cooler to return filter.
- 6 Drill two 5/8" diameter holes through the deck for the hoses from the air driven throttle control. Install the speed control on the engine. Route the hoses through these holes and connect them as shown in the Parts Section.
- 7 Install the barbed nipples, hose and hose clamps from the suction port of the reservoir to the suction filter.
- 8 Drill a 1" hole for the receiver drain as near the drain as possible and route a 1/2" diameter hose through the hole. Connect one end to the receiver drain. This will prevent drainage of the receiver onto the deck of the truck.

- 9 Connect the wiring to the compressor where applicable.
- 10 Fill the oil tank and open suction gate valve. Disconnect pressure hose at hydraulic pump. Engage the PTO and turn the engine with starter until oil comes out the pressure side of the pump. Connect pressure hose. Pull out the compressor switch and open the gate valve to the tank. Disengage the PTO and start the truck engine. Depress the clutch and engage the PTO. Release the clutch slowly. It may be necessary to allow the truck to idle until warmed up enough to pull at idle RPM. Push the compressor switch in. This will close the control valve and start the compressor. Allow the compressor to warm up (See Operation Section). Close the gate valve on the air tank. This will activate the speed control to the proper RPM. Check the system for leaks and proper operation.
- 11 Install compressor kill switch. See figure.

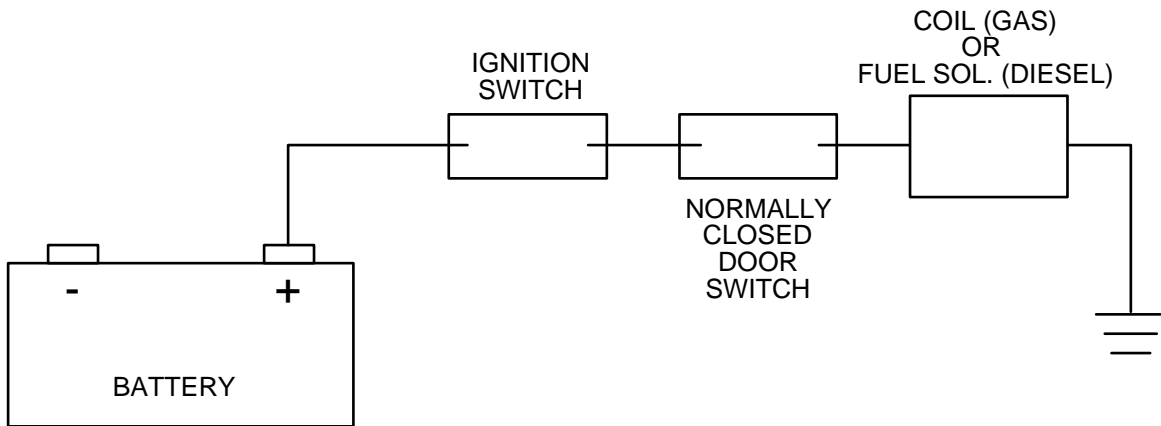

---

## Oil Cooler (optional)

Oil coolers vary in their installation dependent on available space and other considerations. Install the oil cooler in front of the carrier vehicle's radiator, or, as an alternative, in a protective structure which is cooled by an electric fan. See figure for general location within the hydraulic system.

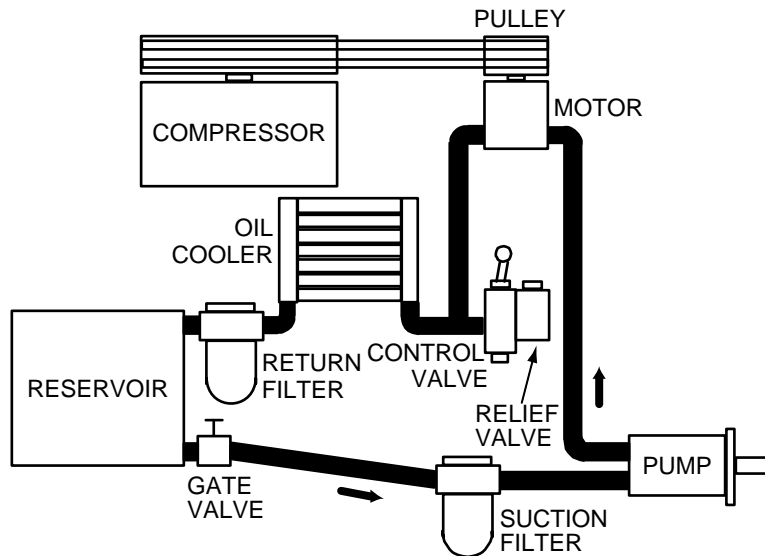



## SECTION 4

# Operation

## Operation

The compressor has an operating time limit of approximately three hours depending upon ambient air temperature (outside air temperature), weather conditions and whether an oil cooler has been installed. Oil coolers will extend the three hour limit.

### CAUTION

THE HYDRAULIC OIL TEMPERATURE MUST NOT BE ALLOWED TO EXCEED 190°F (88°C). IF THE OIL TEMPERATURE REACHES THIS LIMIT, THE SYSTEM MUST BE SHUT DOWN AND ALLOWED TO COOL. OIL COOLERS WILL EXTEND THE THREE-HOUR LIMIT.

To start the compressor:

- 1 Ensure the PTO is disengaged, control valve is open (pull the compressor switch out) and the receiver drain cock is open.
- 2 Start the truck engine and allow it to idle until it reaches the proper operating temperature (refer to the vehicle owner's manual).
- 3 Depress the clutch, engage the PTO and carefully release the clutch pedal. Allow the system to warm up for the time period as shown in chart.

COMPRESSOR WARM-UP TIME	
AMBIENT AIR TEMPERATURE (°F)	IDLING TIME (WARM-UP)
+40° OR ABOVE	NONE
+20° TO +40°	2 - 5 MINUTES
0° TO +20°	5 - 10 MINUTES
-20° TO 0°	10 - 15 MINUTES
-40° TO -20°	15 - 20 MINUTES
BELOW -40°	20 MINUTES MINIMUM

- 4 When starting the compressor, the RPMs will automatically increase due to low volume of air in the system.

### CAUTION

1000 RPM MAXIMUM! Operating this unit in excess of 1000 RPM, measured at the compressor flywheel, will void your warranty. Engine RPM may be different.

- 5 The flow required to the compressor is 16 GPM.

---

## Shutdown

Shut down the compressor system as follows:

- 1 Allow the compressor to build to maximum pressure and the truck engine will automatically idle down.
- 2 Place the compressor control valve in the open (off) position.
- 3 Depress the clutch pedal and disengage the PTO.
- 4 Open the receiver drain cock and discharge the air in the receiver.

### WARNING

Federal law prohibits driving the carrier vehicle on public roads with the receiver filled with compressed air. Always drain the receiver before moving the vehicle.

---

## SECTION 5

# Maintenance & Repair

This section contains instructions for performing the inspection, lubrication, and maintenance procedures required to maintain the compressor in proper operating condition. The importance of performing the maintenance described herein cannot be over emphasized.

The periodic maintenance procedures to be performed on the equipment covered by this manual are listed below. It should be understood that the intervals between inspections specified are maximum interval. More frequent inspections should be made if the unit is operating in a dusty environment, in high ambient temperature, or in other unusual conditions. A planned program of periodic inspection and maintenance will help avoid premature failure and costly repairs. Daily visual inspections should become a routine.

The LUBRICATION AND MAINTENANCE CHART lists serviceable items on this compressor package. The items are listed according to their frequency of maintenance, followed by those items which need only "As Required" maintenance.

The maintenance time intervals are expressed in hours. The hourmeter shows the total number of hours your compressor has run. Use the hourmeter readings for determining your maintenance schedules. Perform the maintenance at multiple intervals of the hours shown. For example, when the hourmeter shows "100" on the dial, all items listed under "EVERY 10 HOURS" should be serviced for the tenth time, and all items under "EVERY 50 HOURS" should be serviced for the second time, and so on.

### DANGER

Compressor must be shut down and completely relieved of pressure prior to checking fluid levels. Open drain valve on air tank, and compressor service valve, to ensure relief of system air pressure. Failure to comply with this warning may cause damage to property and serious bodily harm.

## Maintenance Schedule

ITEM	MAINTENANCE DESCRIPTION	SERVICE INTERVAL (Hours/Months)						
		DAILY	WEEKLY	EVERY 200 HOURS	500/3	1000/6	1500/9	2000/12
COMPRESSOR	Air intake - inspect and clean.							
	Compressor oil level - check, add if needed.							
	Compressor oil - change.							
	Safety valves - operate.							
	Safety valves - clean.							
	Valves - inspect and clean.							
	Inter cooler - clean exterior.							
	Low oil level switch - check.							
V-BELT DRIVE	Belt tension - check.							
RECEIVER	Drain condensation - manual.							
	Safety valves - operate.							
HYDRAULIC DRIVE SYSTEM	Oil reservoir level - check.							
	Filter - check and change.							
	Leaks - check, repair.							
	Safety door switch - check.							
	PTO cable - check.							
	Speed control & reset - check.							
	Hydraulic oil - change.							
GENERAL	Lubrication - check.							
	Bolts - check, tighten if needed.							
	Electrical connections - check.							

Service intervals are listed as hours/months, whichever occurs first.

Under normal operating conditions, oil changes are required every 6 months. When operating in a dirty environment, change the oil and air filter more frequently as your particular operating conditions dictate.

Rev. 20071127



---

## Compressor Hydraulic Oil

The hydraulic oil is the power transmission medium, system lubricant, and coolant. Under normal operating conditions, the hydraulic oil must meet the following viscosity and grade specifications:

AMBIENT TEMPERATURE RANGE	0 - 90°	BELOW 32°	32 - 90°	ABOVE 90°
Minimum Pour Point, °F	-30°	-25°	+10°	+10°
Maximum Viscosity, SSU @ 0° F	4000	4000	---	---
Minimum Viscosity, SSU @ 100° F	140-190	100-130	150-200	200-315
Minimum Viscosity, SSU @ 210° F	40	41	43	47
Minimum Viscosity Index	139	90	90	90

Additives including anti-foam inhibitors, antioxidant inhibitors, rust resistance, and anti-wear must be part of the oil.

Arctic conditions present special requirements which are not in the scope of the table and must be analyzed individually. Consult your oil supplier for proper hydraulic fluids for working under these severe conditions. Electric reservoir heaters are available to improve conditions at extremely low temperatures.

---

## Hydraulic Fluid Deterioration

Contamination of the hydraulic fluid by solvents, water, dust or other abrasives will cause deterioration of the fluid. Sustained presence of the impurities will result in premature breakdown of antifoam, lubrication, anti-rust and viscosity properties. Introduction of water to the system and operation at high temperatures (above 180°F) will result in an increase in the oil oxidation rate. Oxidation produces varnish forming materials and sludge in the oil.

Operating the system on a sustained basis with contaminated or broken down oil will increase wear and can significantly shorten the efficient service life of the unit.

Periodically, draw off a sample of the oil and check the oil for breakdown. To check oil quality:

- 1 Place the oil in a clean glass.
- 2 Smell the oil to detect a burnt or rancid odor.
- 3 Visually examine the oil for a dark or cloudy appearance.
- 4 Allow the sample to stand for several minutes. Inspect the sample for water which will settle to the bottom of the glass if present. Water can result from a system leak or condensation due to temperature extremes.

In case of any of these conditions, the system should be purged and filled with new oil. In addition, the oil should be changed in the reservoir and complete system:

- 1 After every 800 hours of operation or every six months, whichever occurs first.
- 2 After pump or other major hydraulic component failure, drain the hoses.

---

## Compressor Hydraulic Oil Change

Check the oil in the hydraulic reservoir quarterly, and replace the oil on an annual basis.

Purging the system requires a new oil supply sufficient to completely fill the reservoir, lines, cylinders, etc., and an extra quantity for loss during this procedure. To minimize oil loss during this process, operate the truck engine at low RPM.

Two operators are required during the purging operation: one to operate the compressor and the other to regulate pump flow (engine speed).

### CAUTION

**DO NOT ALLOW THE RESERVOIR OIL LEVEL TO DROP BELOW 1/3 CAPACITY DURING THIS OPERATION.**

- 1 Drain the hydraulic oil reservoir. Disconnect the suction hose to the pump, drain and reassemble. Change the suction filter cartridge.

#### NOTE

---

**DISPOSE OF WASTE OIL IN A RESPONSIBLE MANNER, FOLLOWING ANY FEDERAL, STATE, OR LOCAL REGULATIONS.**

---

- 2 Remove the reservoir return line. Direct flow into a sump or waste container. Plug the drain port on the reservoir and fill with new oil.

#### NOTE

---

**READ AND FOLLOW THE FOLLOWING INSTRUCTIONS WITHOUT INTERRUPTION OR STOP THE ENGINE AT THE END OF EACH STEP. IF THIS IS NOT DONE, EXCESS OIL WASTE WILL BE DISCHARGED.**

---

- 3 Start the truck engine and engage the PTO. Slowly release the clutch. Activate the control valve so that the fluid passes through the motor. Allow fluid to discharge for about 15 seconds. Kill the engine.
- 4 Reconnect the return line to the reservoir port. Change the return line filter. All components of the system are now purged.
- 5 Check hydraulic oil level. Top off if necessary.

---

## Compressor Filter Element Replacement

To avoid residue accumulation in the reservoir and to protect the hydraulic components (valves, pumps, motors, etc.), the filters must be serviced on a regular basis.

They must be changed after the initial 50-hours of new unit operation and every 200-hours thereafter. To change filter elements:

- 1 Shut the gate valve and remove the filter element.
- 2 Install the new filter ensuring proper rubber seal seating and tighten as much as possible using both hands.
- 3 Open the gate valve and check for leaks.

### CAUTION

Avoid pump failure! Open the shutoff valve.

---

## Drive Belt

To adjust the drive belt tension and alignment:

- 1 Loosen the four bolts securing the motor mounting bracket to the base plate.
- 2 Turn the drawbolt in a clockwise direction to tighten the belt until there is 1/4" - 1/2" play at the center of the belt between the pulleys.
- 3 Adjust the alignment drawbolt until the motor pulley is square with the compressor. Use a straightedge across the compressor pulley and check the gap between the motor pulley and the straight edge. The gap (1-3/4") on the compressor side of the motor pulley should be the same as on the far side of the pulley.

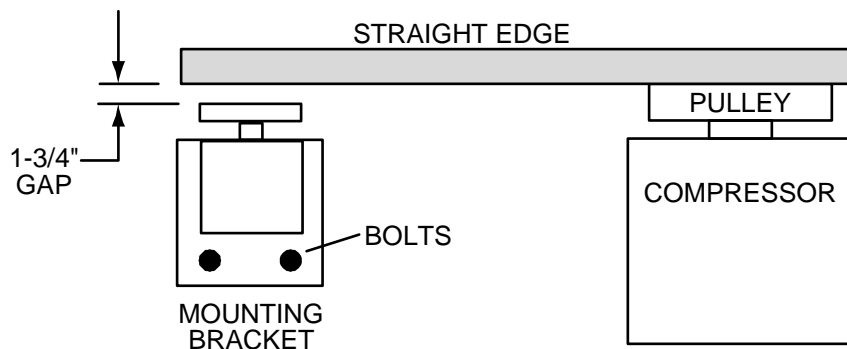

---

## Compressor Hydraulic System Precautions

To avoid malfunction of the compressor hydraulic system, follow these steps whenever a hydraulic component is removed from the system.

- 1** ALWAYS relieve internal hydraulic pressure before proceeding with a repair. Carefully loosen a fitting and allow the pressure to bleed off.
- 2** NEVER allow foreign matter (dirt, water, metal particles, etc.) to enter the system through the open connections. Cap or plug any openings. If dirt does get in, a filter change is required after 50 hours of operation.
- 3** ALWAYS check for high pressure leaks after completing a repair. A high pressure leak is hazardous and must be repaired.

## Troubleshooting Guide

Compressor Troubleshooting Guide	
Symptom	Probable Cause
Air compressor slows down as air pressure increases and the engine RPM remains the same, or increases slightly.	<ol style="list-style-type: none"> <li>1 Relief valve bypassing oil. Adjust relief valve. Turn clockwise to increase bypass pressure. If this does not correct the problem, return the relief valve to the original position. Proceed with step #2.</li> <li>2 Hydraulic pump failure. Disconnect the pressure hoses at the motor inlet swivel. Cap the hose. Plug the swivel. If the system does not have a pressure gauge, install one at the end of the hose for testing purposes. Engage the PTO and release the clutch slowly. Hydraulic oil pressure should reach 2300 - 2500 PSI before the relief valve opens.</li> <li>3 Hydraulic motor or valve failure. Disconnect the pressure hose from the pump at the gauge swivel. Connect the pressure hose from the pump to the motor inlet swivel. Shut control valve. engage the PTO. Start the compressor. If this does not correct the problem, replace the motor. If this does correct the problem, replace the valve.</li> </ol>
Motor does not turn when hydraulic valve is closed. Oil does not reach 2300 - 2500 psi.	<ol style="list-style-type: none"> <li>1 Compressor is locked up. Disconnect the drive system and try to turn the compressor by hand. If it cannot be turned, repair the compressor.</li> <li>2 Hydraulic motor failure. Replace the motor if the compressor is operational.</li> </ol>
Motor does not turn when the hydraulic system is activated. Relief valve reached 2300 - 2500 psi.	<ol style="list-style-type: none"> <li>1 Hydraulic motor is beginning to fail. Replace the hydraulic motor before it damages the rest of the system.</li> </ol>
Excessive noise in hydraulic pump. Pump gets very hot.	<ol style="list-style-type: none"> <li>1 Restrictions in oil hoses and fittings. Check and correct any restrictions.</li> <li>2 Oil tank vent plugged. Check and clean oil tank vent.</li> <li>3 Hydraulic oil breakdown. Drain and replace.</li> </ol>
Hydraulic system damages pumps. Oil tank overflows.	<ol style="list-style-type: none"> <li>1 Tank too full to allow for expansion. Drain excess oil.</li> <li>2 Oil tank vent plugged. Check and clean.</li> </ol> <p>NOTE: If your truck has two tanks, the return hose from the top tank to the lower tank may be restricted.</p>
Oil is cold. Compressor is started cold and fails to continue to operate.	<ol style="list-style-type: none"> <li>1 Compressor started too quickly. Insufficient warm-up causes pump failure. Replace pump, start compressor, and allow sufficient warm-up time.</li> </ol>

## SECTION 6

# Parts

## CAS440HT Compressor Parts (23000080)

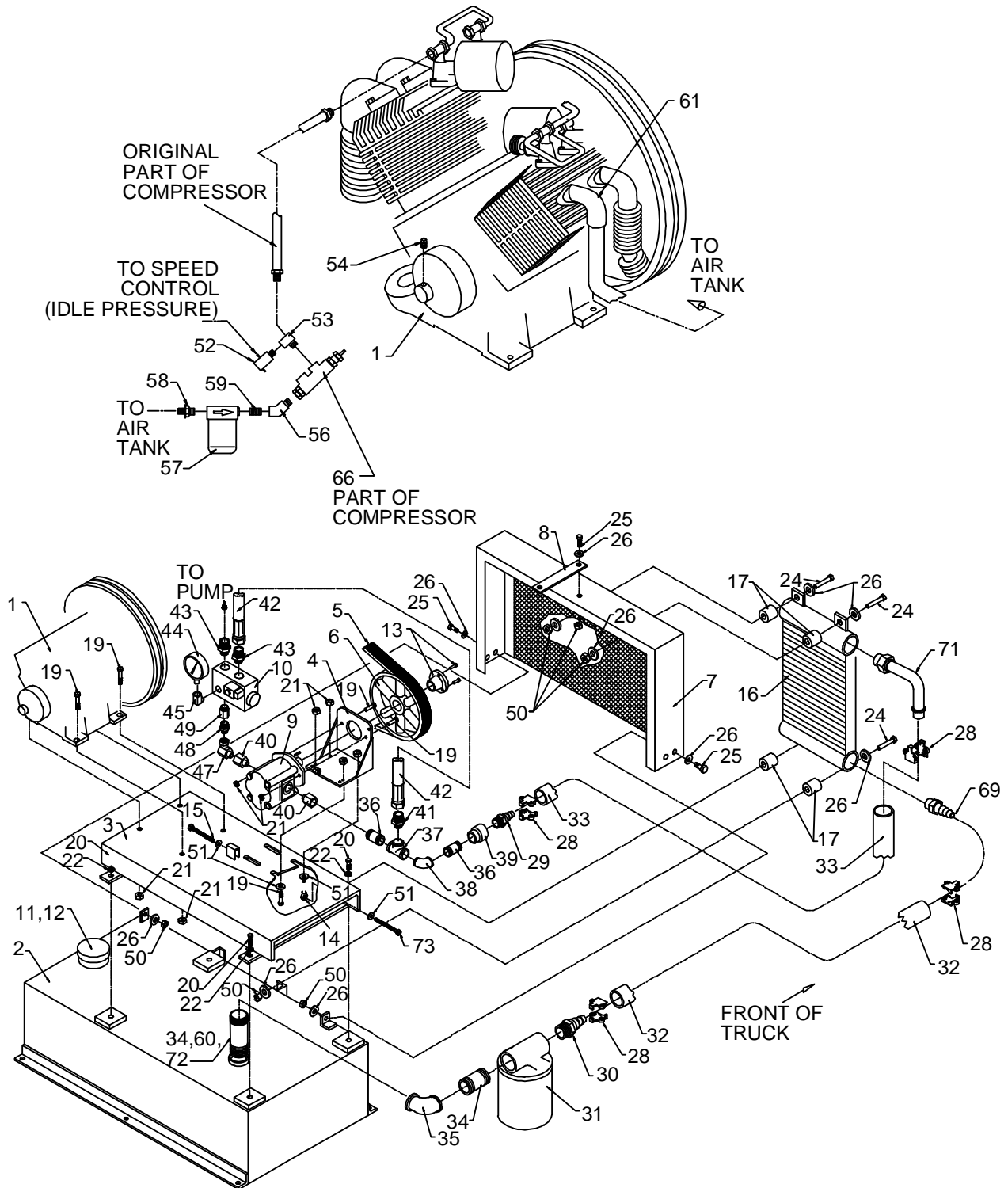





23000080 PARTS LIST			
ITEM	PART #	DESCRIPTION	QUANTITY
1.	70073051	COMPRESSOR	1
2.	52719724	RESERVOIR	1
3.	52720047	BASE WELDMENT	1
4.	52724369	BRACKET (WAS 52070749)	1
5.	70058486	BELT-POWER V 2B80	1
6.	70056043	PULLY-BROWNING 2BK110H	1
7.	52705590	BELT GUARD	1
8.	60104650	BRACE	1
9.	73051614	HYD MOTOR-M20A897BEEF10	1
10.	73540449	RELIEF VALVE (WAS 73054995)	1
11.	73014671	FILL CAP	1
12.	73141276	FILL NECK SCREEN	1
13.	60106708	BUSHING	1
14.	52702304	BOLT-CMPRSR HOLD DOWN	1
15.	52706302	TIGHTENER BOLT 8"	2
16.	73052133	OIL COOLER	1
17.	60104673	SLEEVE .39X1X1.19	2
19.	72060094	CAP SCR 1/2-13X1-3/4 HHGR5	9
20.	72060091	CAP SCR 1/2-13X1 HHGR5	4
21.	72062080	NUT 1/2-13 LOCK	10
22.	72063053	WASHER 1/2 LOCK	4
24.	72060008	CAP SCR 1/4-20X2 HHGR5	2
25.	72060004	CAP SCR 1/4-20X1 HHGR5	3
26.	72063001	WASHER 1/4 WRT	13
28.	72661642	HOSE CLAMP 1-3/4 T-BOLT (WAS 72066516)	4
29.	72532833	BEAD NIPPLE 1MPT 1-1/4HOSE	2
30.	72531550	BARB NIPPLE 1-1/4MPT 1-1/4	1
31.	73052091	RETURN FILTER 10MIL 1-1/4FPT	1
32.	89393401	HOSE 1-1/4 100R4	40"
33.	89393401	HOSE 1-1/4 100R4	60"
34.	72053211	PIPE NIPPLE 1-1/4NPT X CLOSE	1
35.	72053327	ELBOW 1-1/4NPT 90°	1
36.	72053141	PIPE NIPPLE 3/4NPT X CLOSE	2
37.	72053604	TEE 3/4NPT	1
38.	73053285	STREET ELBOW 3/4NPT 90°	1
39.	72053436	REDUCER COUPLING 1.0-3/4NPT	1
40.	72053747	ADAPTER #12MSTR 3/4FPT	1
41.	72053676	ADAPTER 3/4MPT #12MJIC	1
42.	51705296	HOSE ASM 3/4X20 FF	1
43.	72532367	ADAPTER #16MSTR #12MJIC	2
44.	73054435	PRESSURE GAUGE 5000PSI	1
45.	72531131	STREET ELBOW 1/4NPT 90°	1
46.	72053747	ADAPTER #12MSTR 3/4FPT	1
47.	72053713	ELBOW 3/4MPT 1/4FPT 90° SWVL	1
48.	72053558	ADAPTER 3/4MPT 3/4MPT	1
49.	72053750	ADAPTER #16MSTR 3/4FPT	1

<b>23000080 PARTS LIST</b>			
ITEM	PART #	DESCRIPTION	QUANTITY
50.	72062104	NUT 1/4-20 LOCK	7
51.	72063005	WASHER 1/2 WRT	6
52.	77041008	PRESSURE SWITCH	1
53.	72532013	STREET TEE 1/4NPT BRASS	1
54.	72053411	PIPE PLUG 1/8NPT SQHD	1
55.	72053371	REDUCER BUSHING 1/4-1/8NPT	1
56.	72053533	STREET ELBOW 1/4NPT 45°	1
57.	70048069	MOISTURE REGULATOR	1
58.	72532552	HOSE FITTING 1/4-1/4 TYPE O	1
59.	72053013	PIPE NIPPLE 1/4NPT X CLOSE	1
60.	72532960	PIPE NIPPLE 1-1/4X11	1
61.	72053245	PIPE PLUG 1/4NPT SQHD	1REF
65.	89086120	OIL-30W NON-DETERGENT	1GAL
66.	73054031	VALVE-UNLOADER 155-175PSI	1REF
67.	70029117	IDENTIFICATION PLACARD	1
69.	72532833	BEAD NIPPLE 1MPT 1-1/4HOSE	1
71.	72532834	NIPPLE-BEAD 90 DEG 1.00 MPT 1.25	1
72.	72053307	COUPLING -BLK 1.25	1
73.	52721052	TIGHTENER BOLT	1
REV. K 20120123			

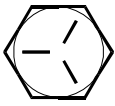
# Thread Torque Charts

FINE THREAD BOLTS (ENGLISH)					
SIZE	BOLT DIA.	GRADE 5  SAE J429 GRADE 5		GRADE 8  SAE J429 GRADE 8	
(DIA-TPI)	(INCHES)	PLAIN	PLATED	PLAIN	PLATED
		(FT-LB)	(FT-LB)	(FT-LB)	(FT-LB)
5/16-24	0.3125	19	14	27	20
3/8-24	0.375	35	26	49	35
7/16-20	0.4375	55	41	78	58
1/2-20	0.5	90	64	120	90
9/16-18	0.5625	120	90	170	130
5/8-18	0.625	170	130	240	180
3/4-16	0.75	300	225	420	315
7/8-11	0.875	445	325	670	500
1-12	1	645	485	995	745
1 1/8-12	1.125	890	670	1445	1085
1 1/4-12	1.25	1240	930	2010	1510
1 3/8-12	1.375	1675	1255	2710	2035
1 1/2-12	1.5	2195	1645	3560	2670

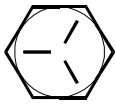
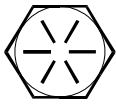

COARSE THREAD BOLTS (ENGLISH)					
SIZE	BOLT DIA.	GRADE 5  SAE J429 GRADE 5		GRADE 8  SAE J429 GRADE 8	
(DIA-TPI)	(INCHES)	PLAIN	PLATED	PLAIN	PLATED
		(FT-LB)	(FT-LB)	(FT-LB)	(FT-LB)
5/16-18	0.3125	17	13	25	18
3/8-16	0.375	31	23	44	33
7/16-14	0.4375	49	37	70	52
1/2-13	0.5	75	57	105	80
9/16-12	0.5625	110	82	155	115
5/8-11	0.625	150	115	220	160
3/4-10	0.75	265	200	375	280
7/8-9	0.875	395	295	605	455
1-8	1	590	445	910	680
1 1/8-7	1.125	795	595	1290	965
1 1/4-7	1.25	1120	840	1815	1360
1 3/8-6	1.375	1470	1100	2380	1780
1 1/2-6	1.5	1950	1460	3160	2370



## NOTES

- 1 Tightening torques provided are midrange.
- 2 Consult bolt manufacturer's particular specifications, when provided.
- 3 Use flat washers of equal strength.
- 4 All torque measurements are given in foot-pounds.
- 5 Torque values specified are for bolts with residual oils or no special lubricants applied. If special lubricants of high stress ability, such as Never-Seez compound graphite and oil, molybdenum disulphide, colloidal copper or white lead are applied, multiply the torque values in the charts by the factor .90. The use of Loctite does not affect the torque values listed above.

## WARNING

Anytime a gear-bearing bolt is removed, it must be replaced with a new bolt of the identical grade and size. Once a bolt has been torqued to 75% of its proof load and then removed, the torque coefficient may no longer be the same as when the bolt was new thus giving indeterminate clamp loads after torquing. Failure to replace gear-bearing bolts may result in bolt failure due to metal fatigue causing death or serious injury.

FINE THREAD TORQUE CHART (METRIC)					
TIGHTENING TORQUE					
SIZE (DIA-TPI)	BOLT DIA. (INCHES)				
		PLAIN (KG-M)	PLATED (KG-M)	PLAIN (KG-M)	PLATED (KG-M)
5/16-24	0.3125	3	2	4	3
3/8-24	0.375	5	4	7	5
7/16-20	0.4375	8	6	11	8
1/2-20	0.5	12	9	17	12
9/16-18	0.5625	17	12	24	18
5/8-18	0.625	24	18	33	25
3/4-16	0.75	41	31	58	44
7/8-11	0.875	62	45	93	69
1-12	1	89	67	138	103
1 1/8-12	1.125	123	93	200	150
1 1/4-12	1.25	171	129	278	209
1 3/8-12	1.375	232	174	375	281
1 1/2-12	1.5	304	228	492	369

COARSE THREAD TORQUE CHART (METRIC)					
TIGHTENING TORQUE					
SIZE (DIA-TPI)	BOLT DIA (INCHES)				
		PLAIN (KG-M)	PLATED (KG-M)	PLAIN (KG-M)	PLATED (KG-M)
5/16-18	0.3125	2	2	3	2
3/8-16	0.375	4	3	6	5
7/16-14	0.4375	7	5	10	7
1/2-13	0.5	10	8	15	11
9/16-12	0.5625	15	11	21	16
5/8-11	0.625	21	16	30	22
3/4-10	0.75	37	28	52	39
7/8-9	0.875	55	41	84	63
1-8	1	82	62	126	94
1 1/8-7	1.125	110	82	178	133
1 1/4-7	1.25	155	116	251	188
1 3/8-6	1.375	203	152	329	246
1 1/2-6	1.5	270	210	438	328

NOTES

- 1 Tightening torques provided are midrange.
- 2 Consult bolt manufacturer's particular specifications, when provided.
- 3 Use flat washers of equal strength.
- 4 All torque measurements are given in kilogram-meters.
- 5 Torque values specified are for bolts with residual oils or no special lubricants applied. If special lubricants of high stress ability, such as Never-Seez compound graphite and oil, molybdenum disulphide, colloidal copper or white lead are applied, multiply the torque values in the charts by the factor .90. The use of Loctite does not affect the torque values listed above.

WARNING

Anytime a gear-bearing bolt is removed, it must be replaced with a new bolt of the identical grade and size. Once a bolt has been torqued to 75% of its proof load and then removed, the torque coefficient may no longer be the same as when the bolt was new thus giving indeterminate clamp loads after torquing. Failure to replace gear-bearing bolts may result in bolt failure due to metal fatigue causing death or serious injury.